

# Magnetic Characterization of 1.5 m Long Superconducting Undulator Coils with 20 mm Period Length

IBPT – Institute for Beam Physics and Technology

**Andreas Grau**

for

**S. Casalbuoni<sup>1</sup>, A. Grau<sup>1</sup>, N. Glamann<sup>1</sup>, T. Holubek<sup>1</sup>, D. Saez de Jauregui<sup>1</sup>, C. Boffo<sup>2</sup>, Th. Gerhard<sup>2</sup>, M. Turenne<sup>2</sup>, W. Walter<sup>2</sup>**

<sup>1</sup> **Karlsruhe Institute of Technology, Karlsruhe, Germany**

<sup>2</sup> **Bilfinger Noell GmbH, Würzburg, Germany**

- Introduction
- KIT and BNG SCUs development
- Magnetic measurement equipment at the IBPT - CASPER I + II
- SCU 20 coils
- Training
- Local magnetic field measurements
- Calculated spectrum
- Magnetic field integrals and multipoles
- Summary

# R&D of Superconducting Undulators

Develop, manufacture, and test superconducting undulators (SCUs) to generate:

- Harder X-ray spectrum
- Higher brilliance X-ray beams

with respect to permanent magnet undulators.

Why?

Larger magnetic field strength for the same gap and period length.

- Further advantage is radiation hardness demonstrated for NbTi magnets (i.e. Hera Tevatron, LHC)

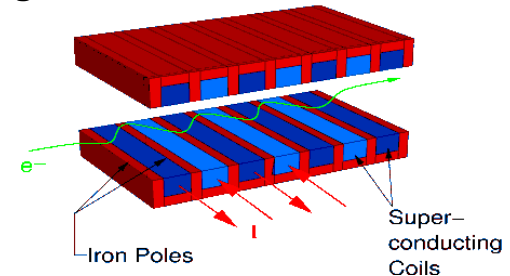

Same magnetic length = 2 m and vacuum gap = 5 mm

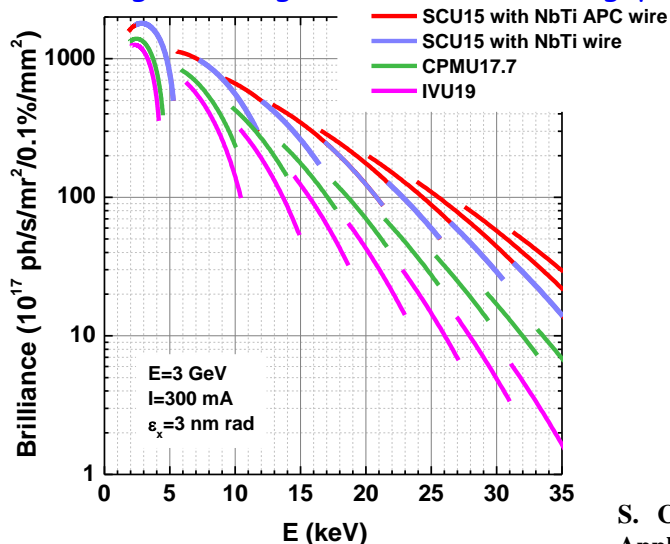

	IVU* (SLS)	CPMU† (DLS)	SCU NbTi wire**	SCU NbTi APC††
$\lambda_u$ [mm]	19	17.7	15	15
# of periods	105	112	133	133
magn. Gap [mm]	5	5.2	6	6
B [T]	0.86	1.04	1.18	1.46
K	1.53	1.72	1.65	2.05

IVU = in-vacuum undulator,  
 CPMU = cryogenic permanent magnet undulator,  
 SCU = superconducting undulator

\* F. Bødker et al., EPAC06  
 † C.W. Ostenfeld & M. Pedersen, IPAC10  
 \*\* D. Saez de Jauregui et al., IPAC11  
 †† T. Holubek et al., IPAC11

S. Casalbuoni et al., IEEE Trans. on Appl. Supercon. 4101305, Vol. 24-3 (2014)

KIT and Bilfinger Noell develop, manufacture, and test superconducting undulators (SCUs) for the KIT synchrotron and low emittance light sources.

- NbTi wire
- Conduction cooling => no need of cryogenic fluids
- Movable vacuum chamber: highly desirable during commissioning and "nice to have" during operation



Mockup1

0.15 m

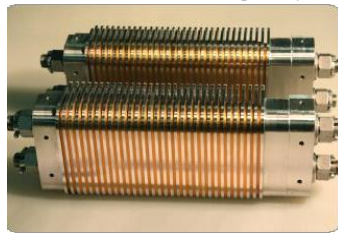

SCU15

Mockup2

0.30 m



Long coils

1.5 m

time

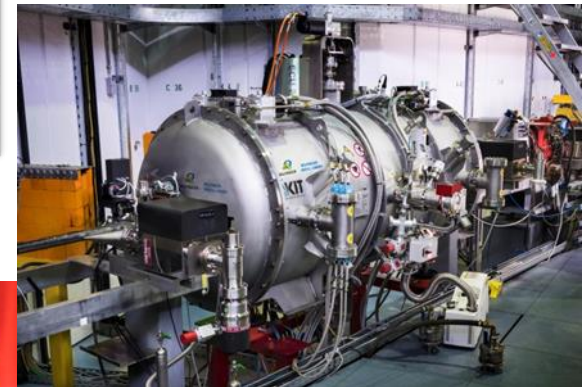

SCU20

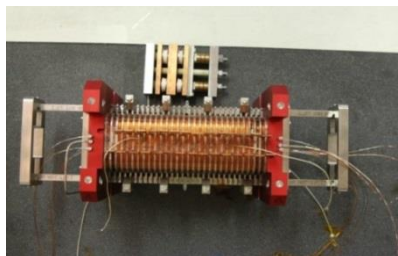

## Characterization Setup for Field Error Reduction

**CASPER I** - Measurement setup for short undulator mock-up coils

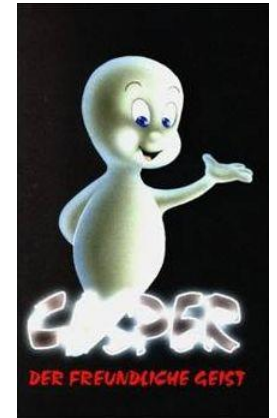
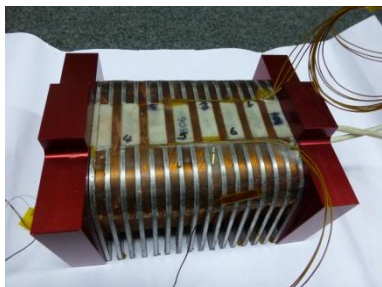

**CASPER II** - A measurement system for undulator coils up to 2m length

## The goal...

Measure magnetic field distributions of superconducting coils with dimensions like in „real“ IDs (e.g. up to ~2 m length, ~50 cm diameter, conduction cooled, arrangement horizontally)



Field integral measurements:

- Stretched wire

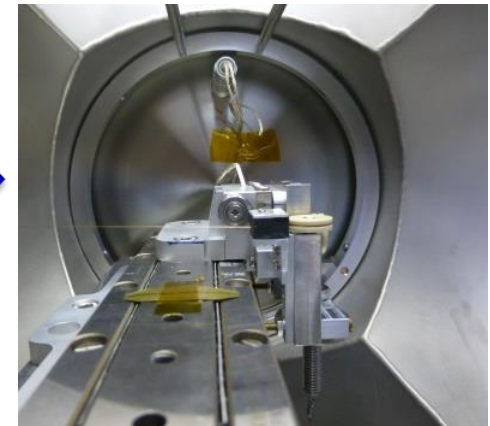

Magnet training:

- Quench detection
- Quench analysis



Local field measurements:

- 3 Hall probes

A. Grau et al.,  
IEEE Trans. on  
Appl. Supercond.  
9001504 22-3 (2012)

## Local field measurements

- Hall probe mounted on a sledge moving along the undulator length sliding on precisely machined guiding rails
- Hall probe calibrated to  $\pm 90 \mu\text{T}$  (PPMS System at Institute for Technical Physics)
- Longitudinal position measured with a laser interferometer with sub  $\mu\text{m}$  resolution

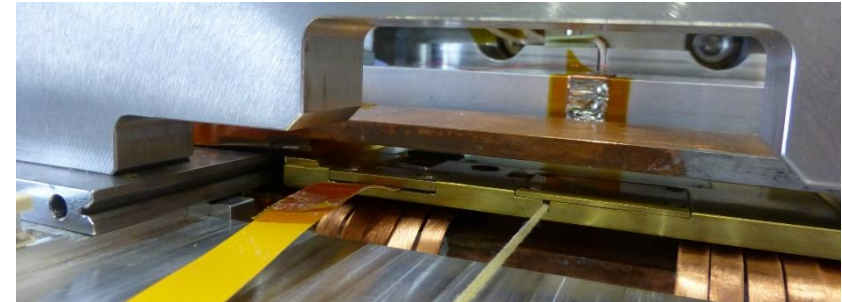

## Integral field measurements

- CuBe wire with a diameter of  $125 \mu\text{m}$  is stretched between two piezo stages placed at a distance of 2.7 m (strain force 6 N)
- Alignment coils magnetic plane to stretched wire movements measured only at room temperature with a precision of  $50 \mu\text{m}$
- Reproducibility of  $I_1$  is  $\pm 2 \times 10^{-6} \text{ T mm}$  and of  $I_2$  is  $\pm 1 \times 10^{-5} \text{ T mm}$

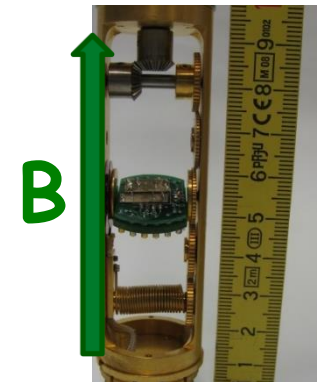

**Local and integral field measurements can be performed during the same thermal cycle !!!**

S. Gerstl et al., IPAC15

A. Grau et al., IEEE Trans. on Appl. Supercond., Vol. 26-4, June 2016

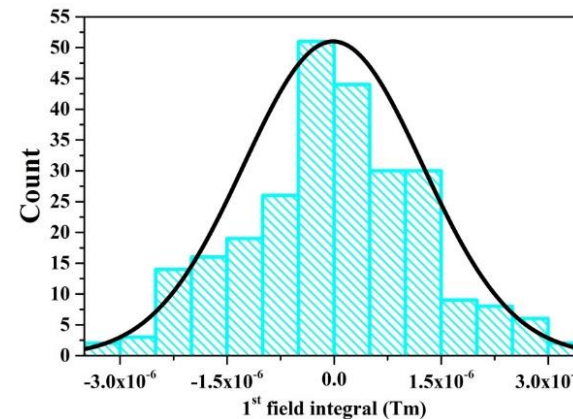

260 consecutive measurements show the reproducibility of the 1<sup>st</sup> vertical field integral measured with stretched wire.

- Period length 20 mm
- Number of full periods 74.5
- Peak field on axis 1.187 T
- Magnetic gap 8 mm
- Each coil is made by 11 blocks
- Round NbTi wire 0.76 mm (incl. insulation)
- End fields upstream and downstream
- Correction coils, NbTi wire 0.254 mm diameter (incl. insulation)

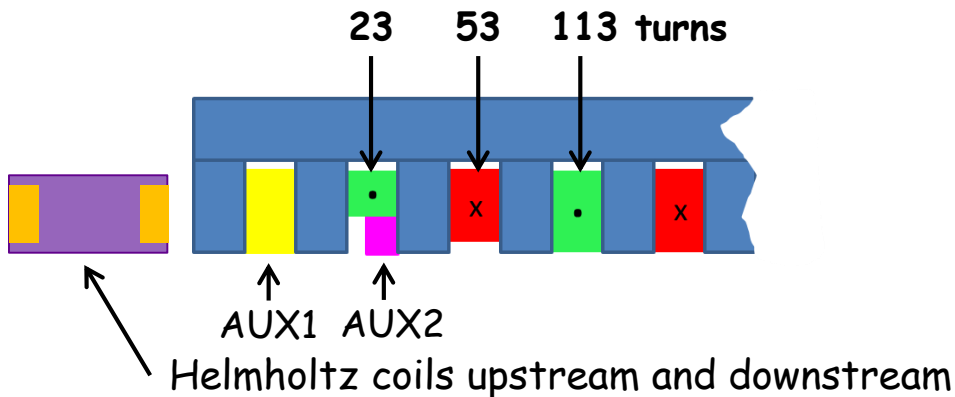
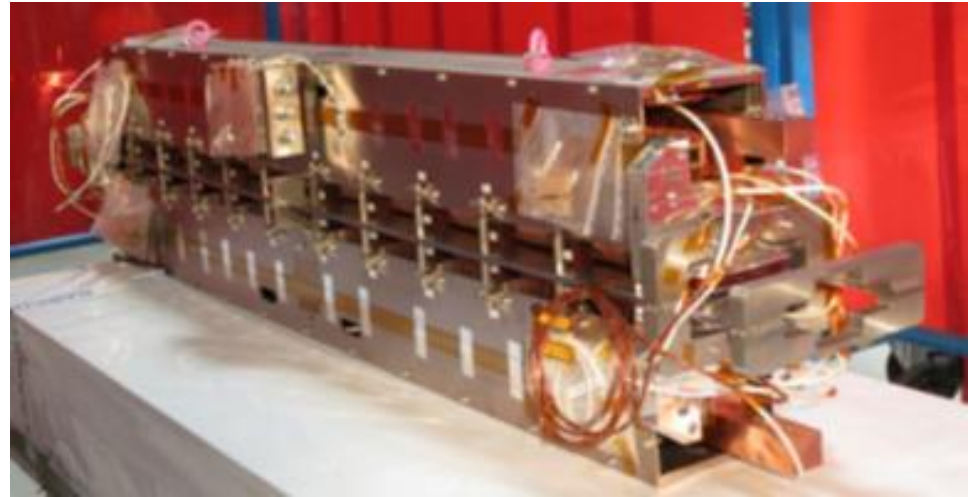

AUX 1 and HH DS have been used to keep

$$|I_{1v}| < 3 \times 10^{-5} \text{ Tm}, \text{ and } |I_{2v}| < 4 \times 10^{-4} \text{ Tm}^2$$

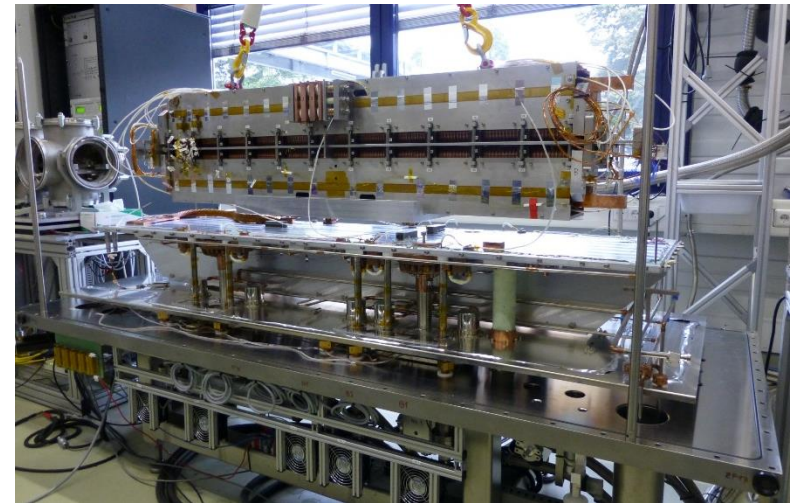

S. Casalbuoni et al, J. Phys.: Conf. Ser. 874 012015 (2017)



- Cooldown time < 6 days
- Coils minimum temperature 3.1K - 3.2K
- Temperature gradient along cooling line 0.1K
- Coils connected to 2 cryocoolers 1.5W @ 4.2K

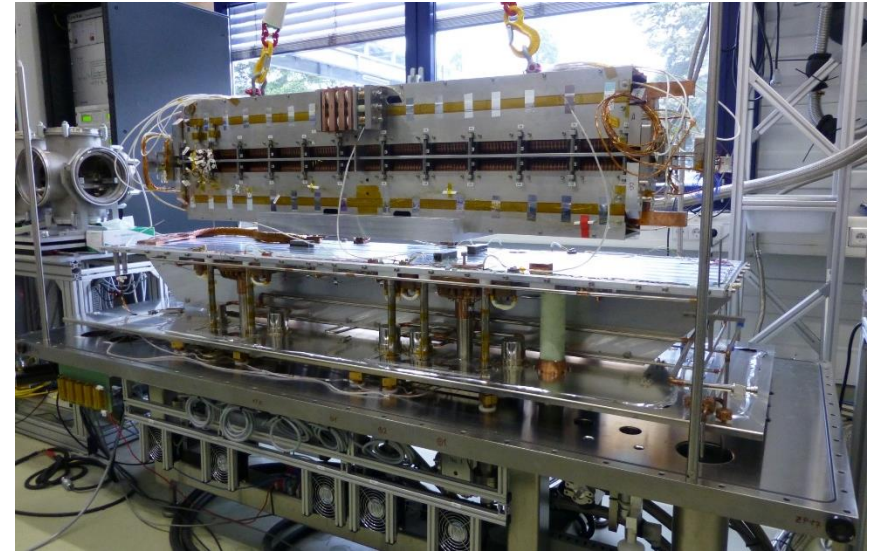
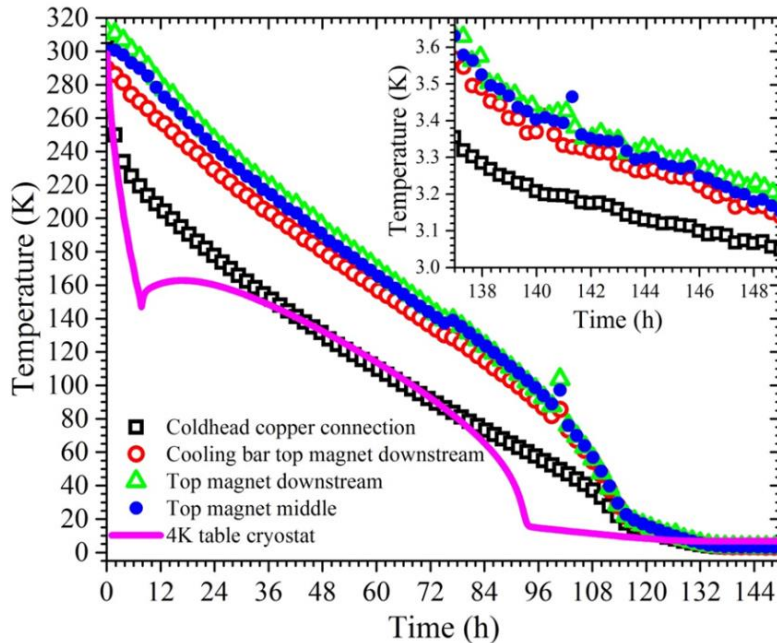

A. Grau et al., IPAC17 (2017)

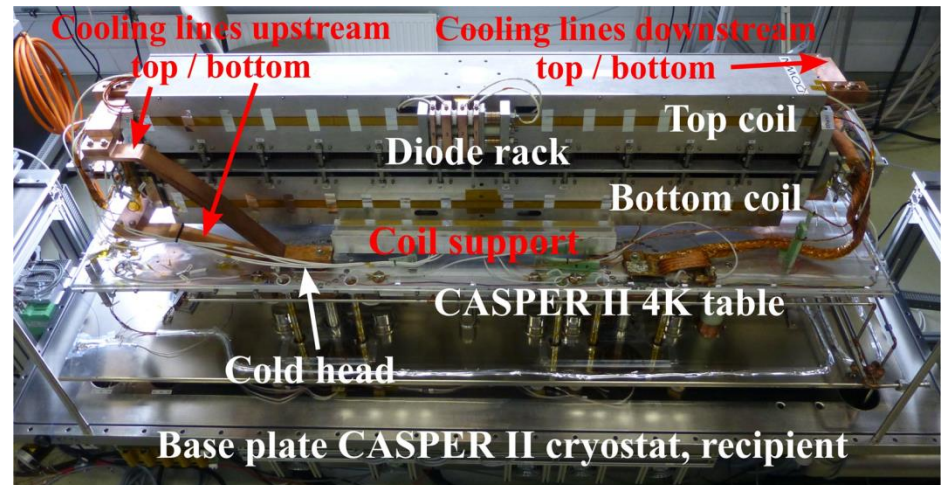

## Quench detection:

- 4 quench detectors built by IPE (Institute for data Processing and Electronics) at KIT
- It was a development for German fusion experiment W7-X
- Settings:  $\pm 50$  mV, 10 ms

## Quench analysis

- National Instruments PXI system with 64 simultaneously readable channels
- Max. 250 kS/s per channel
- Circular buffer  $\pm 0.5$  s (adjustable) relative to trigger from quench detector
- Connector board allows easy connection of any signal from the cryostat to any channel of the PXI

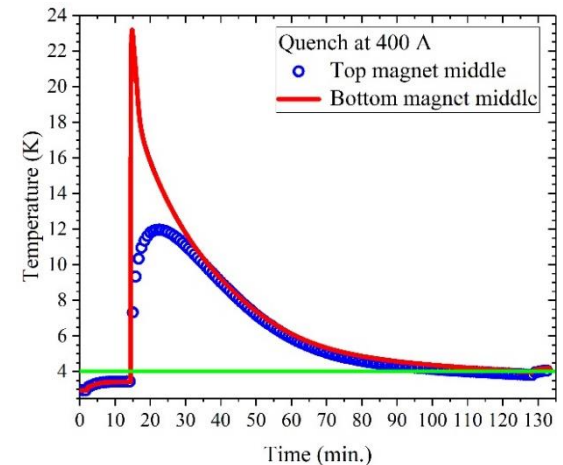
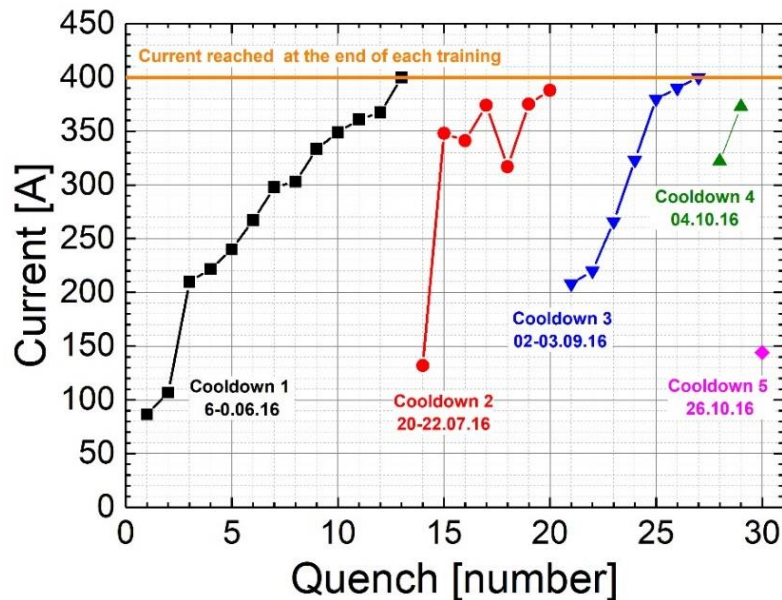

Temperature rise after quench (400 A)  $\sim 20$  K  
Temperature  $\sim 4$  K recovered after  $\sim 90$  min.

A. Grau et al., IPAC17

# Local field measurement equipment

## Measurement sledge:

- Pulled through the magnet on stainless steel guiding rails by two synchronous stepper motors
- 3 Hall samples in a row perpendicular to the beam with 10mm spacing
- „Small sledge“ on measurement sledge allows shifting of middle Hall probe  $\pm 10\text{mm}$ 
  - ➔ Peak field comparison of all samples possible, reduces errors
- Shifting of the Hall probes with stretched wire piezo stage
- Position along beam axis measured by laser interferometer
  - ➔ Precise z-positioning  $\sim 10^{-6}\text{m}$

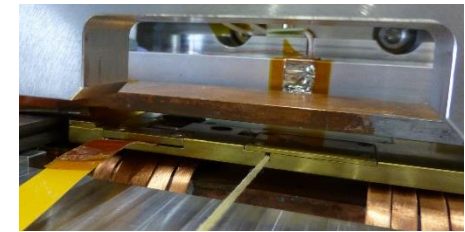
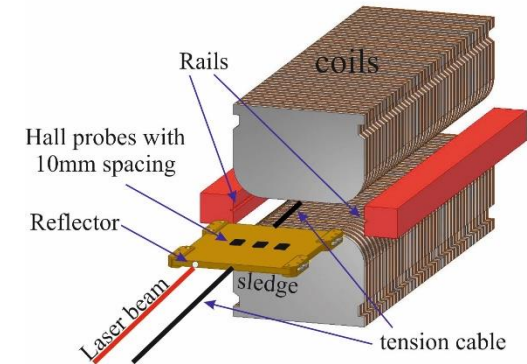

Retroreflector



Hall samples on „small“ sledge    Guiding rails    Retro-reflector

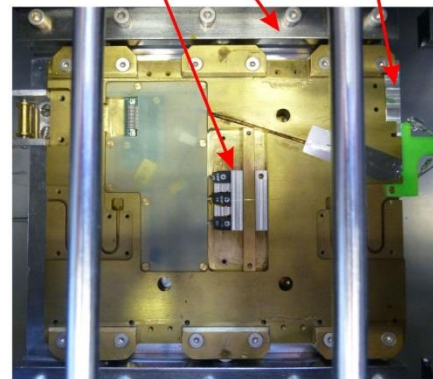

Pulling wire    Piezo stages (stretched wire measurement)    Stick for shifting Hall samples

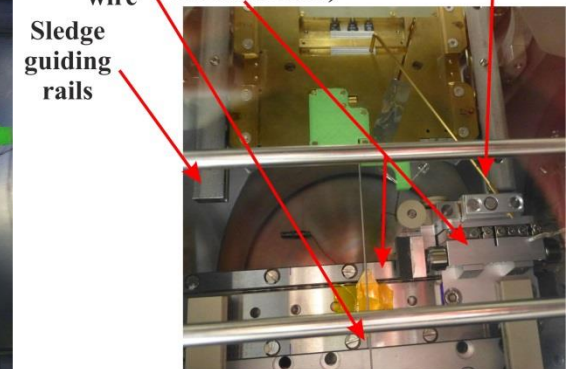

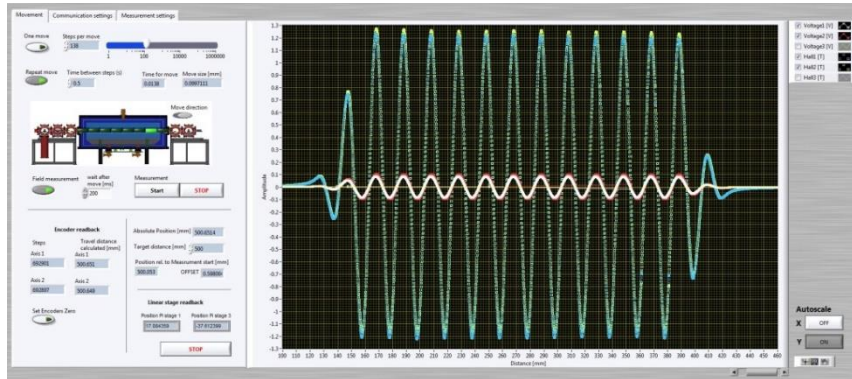

## First measurements of „full scale“ SCU coils

- Measurement length 1800 mm
- Step wise ( $50 \mu\text{m}$ ) data logging
- Laser interferometer working over long range
- Stable field measurement
- Several different currents in main coils 0 A - 395 A
- Correction coils currents adjusted according to field integral optimization (see later)

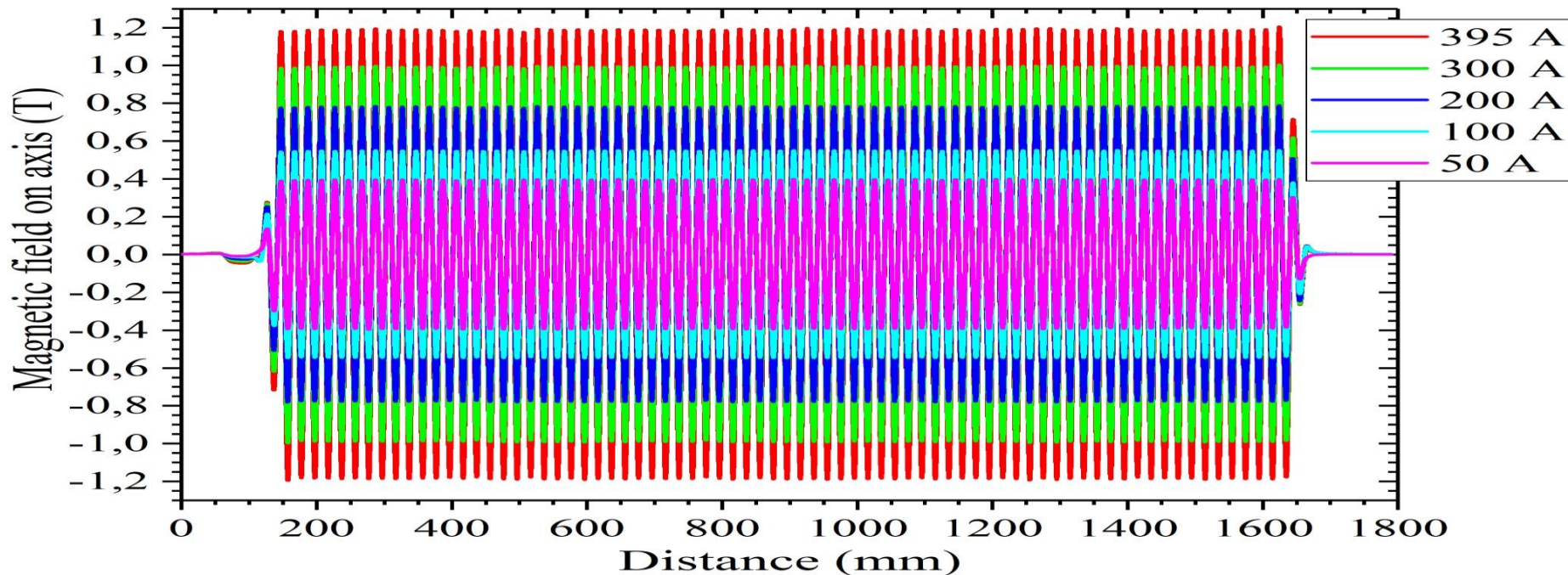

To reach good field quality in cold conditions, required to maximize the spectral response, it is necessary to precisely manufacture the yoke and wind the coils.

Measurements with a CMM at room temperature, deviation from ideal values:

(Pole and winding heights after impregnation, half period length before winding)

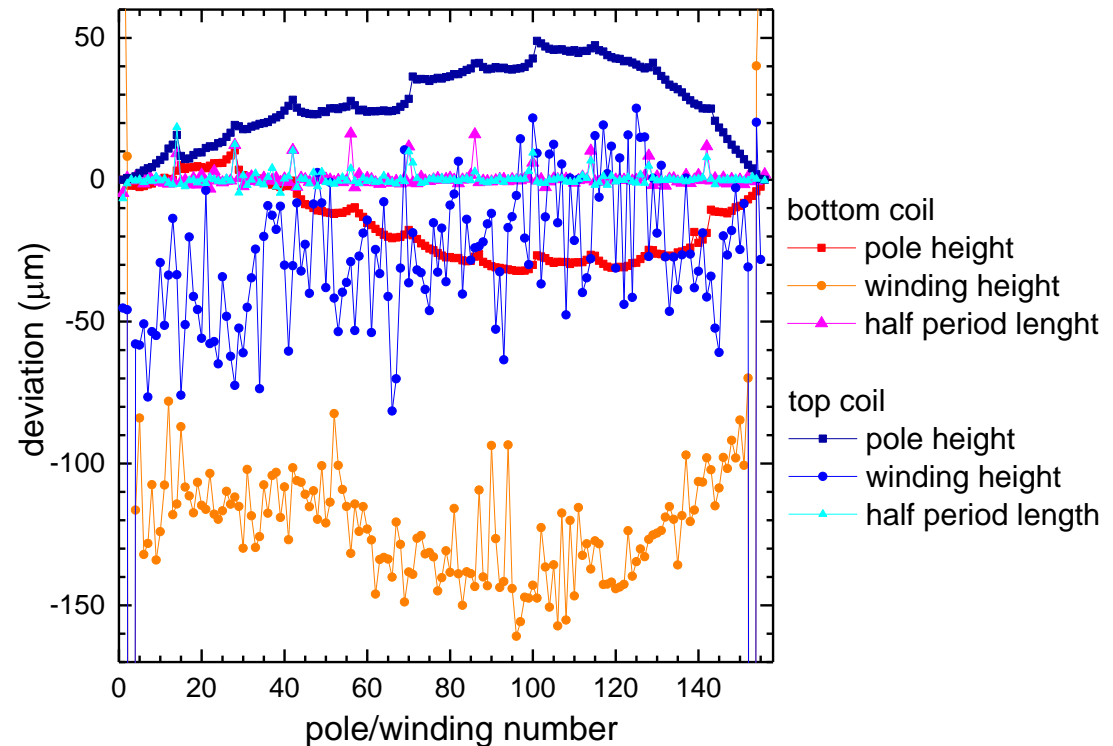
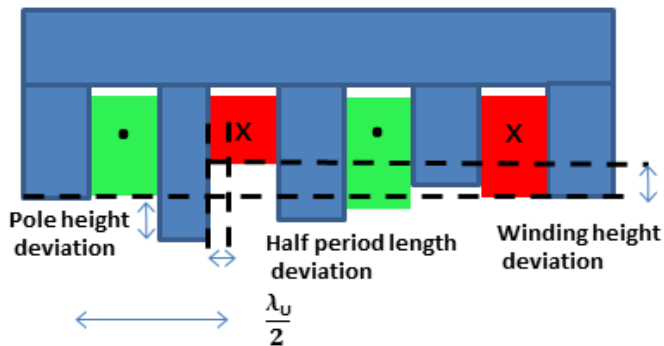

S. Casalbuoni et al, IEEE TransTrans. on Appl. Supercond. 4100704 Vol. 28-3 (2018)

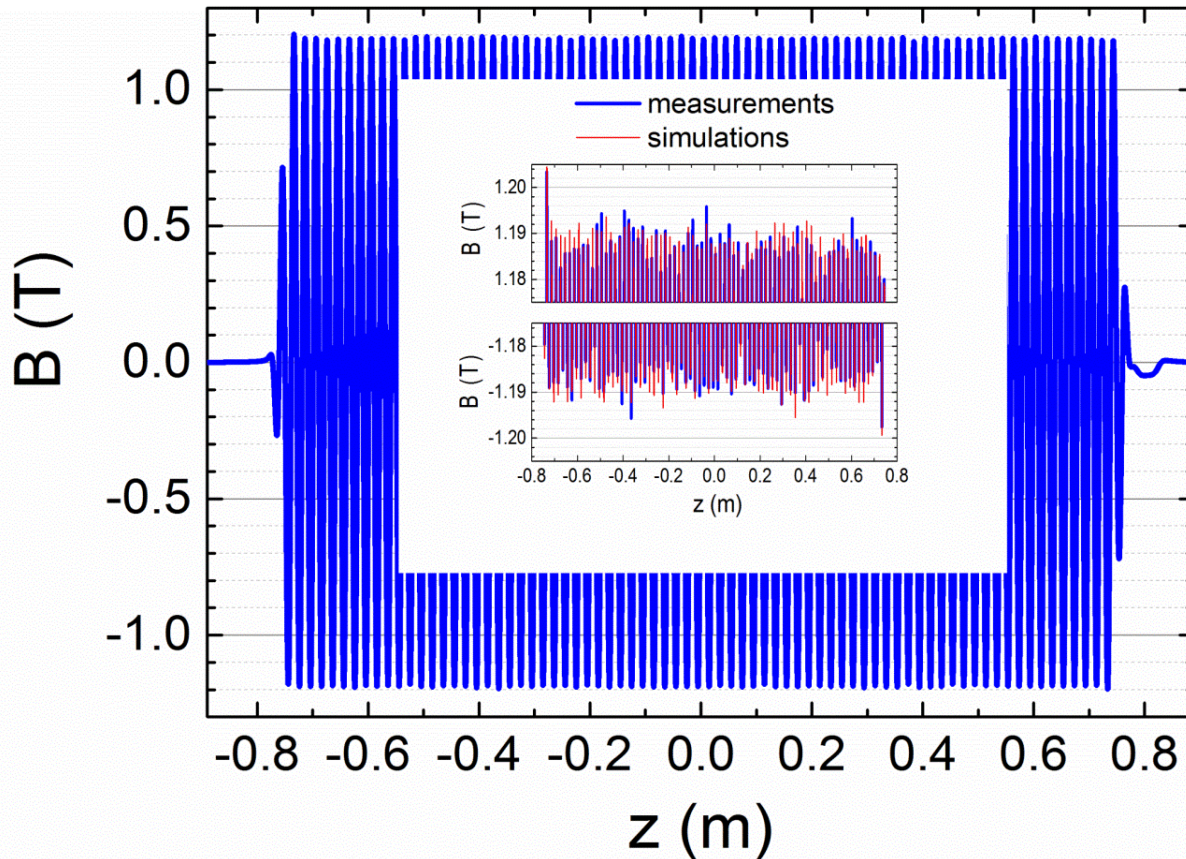

$$I_{\text{main coil}} = 395 \text{ A}$$

Simulations performed with Radia\* considering mechanical accuracies measured at room temperature.

What happens after cooling?

- Observed changes are consistent with random changes in the winding packages height of  $\sim \pm 50 \mu\text{m}$
- Generally good agreement between calculations based on RT mechanical measurements and field measurements.

\*P. Elleaume, O. Chubar, J. Chavanne, PAC97

$I_{\text{Main coil}} = 395 \text{ A}$   
 $I_{\text{AUX1}} = 5.6 \text{ A}$   
 $I_{\text{HH DS}} = 0.82 \text{ A}$

$$\text{Roll off} = \frac{|B(x = \pm 10\text{mm}) - B(x = 0\text{mm})|}{|B(x = 0\text{mm})|}$$

3 different positions (-10mm, 0mm, +10mm) measured by shifting the middle Hall sample.

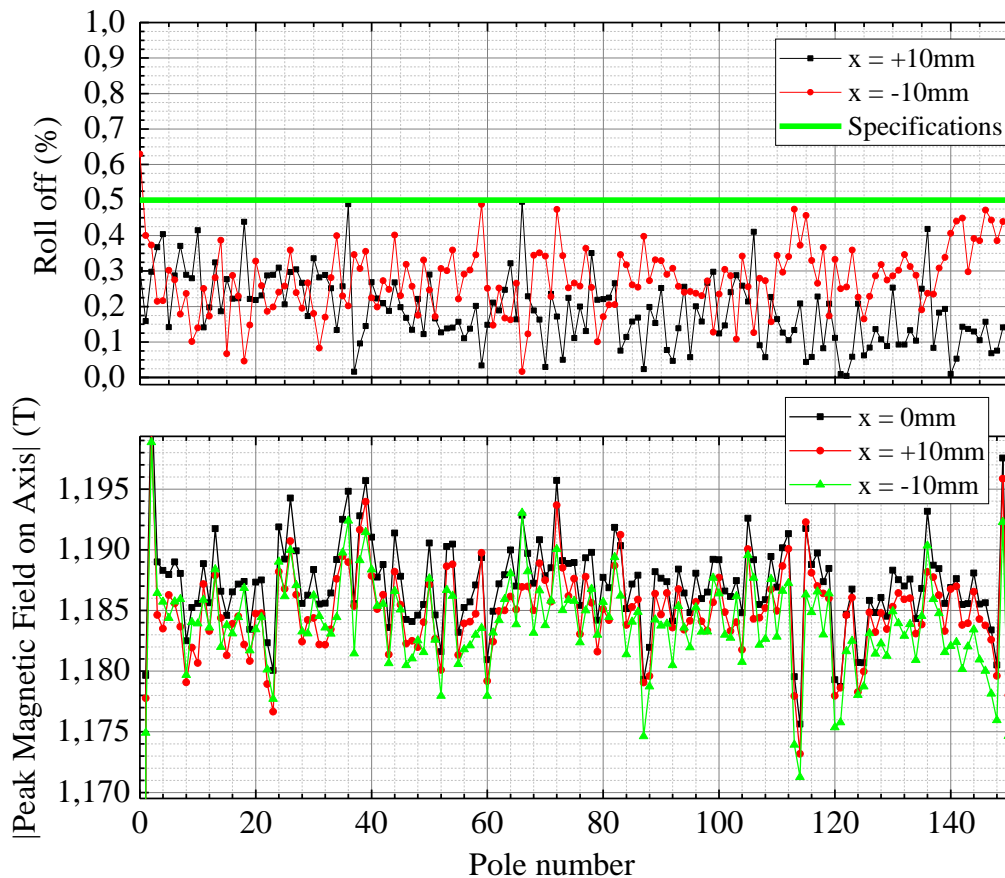

All currents

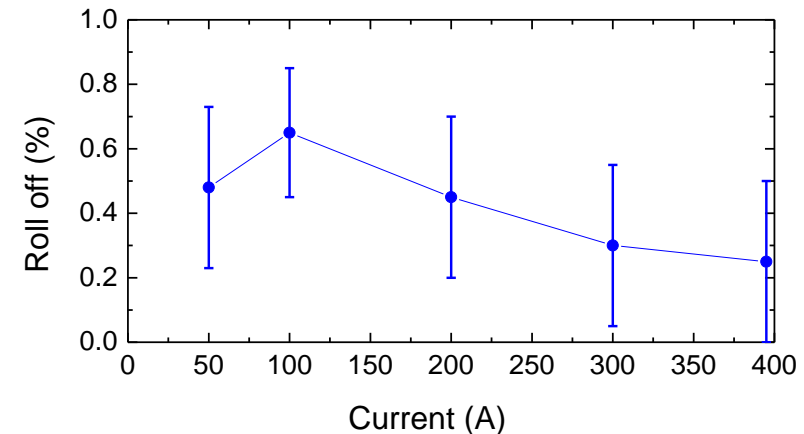

The measured roll off induces a negligible kick on the e-beam.

S. Casalbuoni et al., J. Phys.: Conf. Ser. 874 012015 (2017)

Flux at 10 m from the source through a slit  $50 \mu\text{m} \times 50 \mu\text{m}$  at KIT storage ring KARA

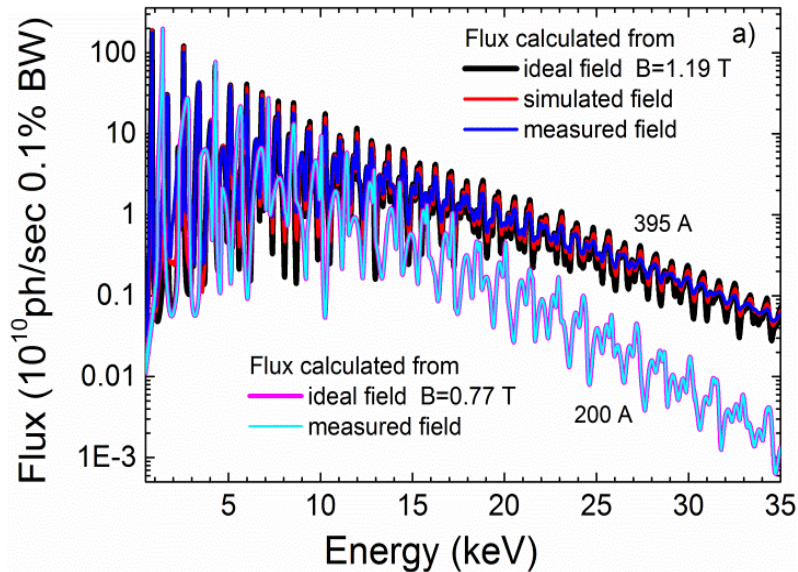

A slight reduction (less than 28% up to 35 keV) in flux of the spectrum from the measured field with respect to the ideal case, for the odd harmonics, due to the mechanical errors and to the non-ideal end field configuration, is observed.

The reduction in flux of the spectrum from the measured field to the ideal one at the odd harmonics is much smaller at lower currents in the main coils.

The reduction in flux is maximal at the 9th harmonic, and it decreases for the higher odd harmonics.

The spectrum from the simulated field at the odd harmonics is very close to the ideal case: a maximal reduction of 10% is observed.

S. Casalbuoni et al, *IEEE Trans. on Appl. Supercond.* 4100704 Vol. 28-3 (2018)

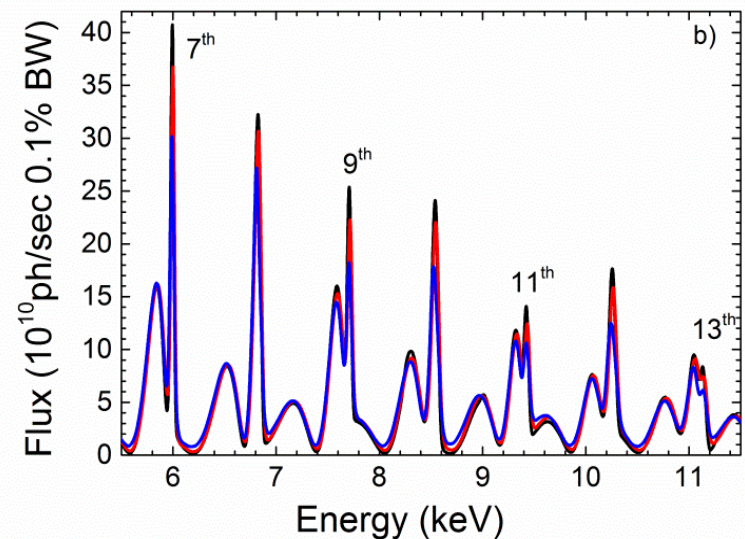

**An improvement in the spectral performance could be obtained by using a rectangular wire.**



# Field integral measurement setup



# Field integral measurement setup

## Moving stretched technique

- Wire is moved by vertical and horizontal piezo stages one at each end of the cryostat in the vacuum crosses
- Positioning precision  $\sim 1 \mu\text{m}$
- Wire tension is applied via constant force spring (6N)

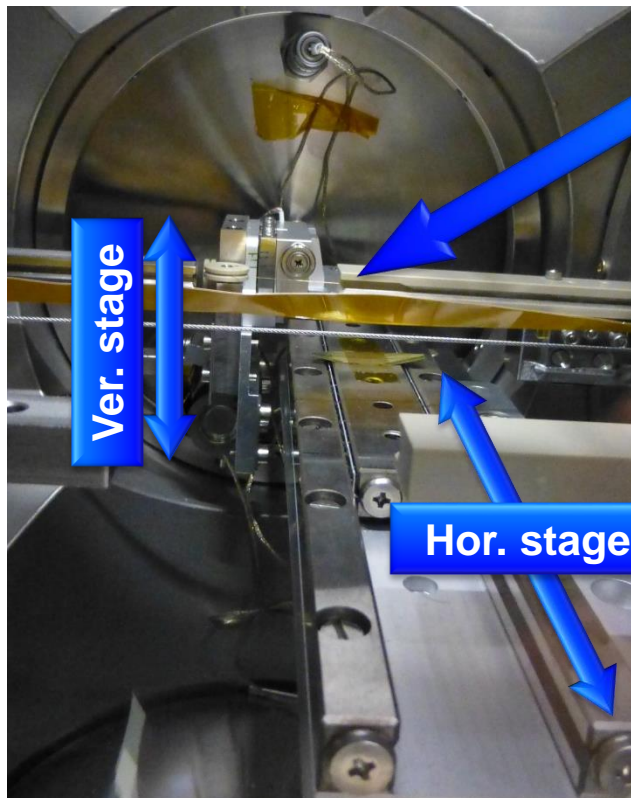

Stretched wire

- The induced voltage is amplified by a FEMTO DLPVA and measured by a Keithley Nanovoltmeter.

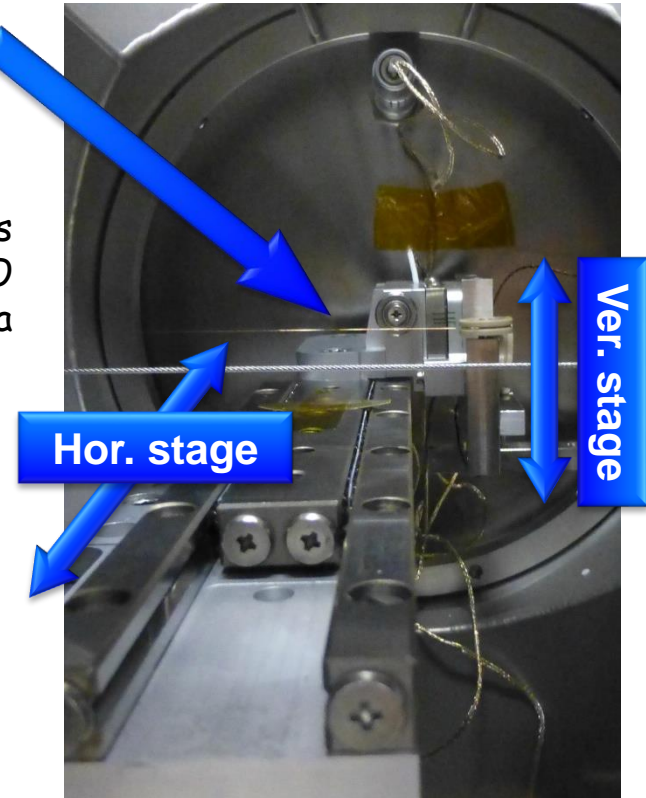

## Field integral optimization (1<sup>st</sup> and 2<sup>nd</sup> vertical integral)

- Set the current in the main coils
- Perform integral measurements
- Power end field correction coils separately
- Vary the set currents for each correction coil individually (Work with optimization table controlling  $I_{\text{Main coils}}$ ,  $I_{\text{Corr coils}}$  and the stretched wire measurement.
- Perform at each step a field integral measurement (1<sup>st</sup> and 2<sup>nd</sup>)
  - Results in a set-current - field integral map

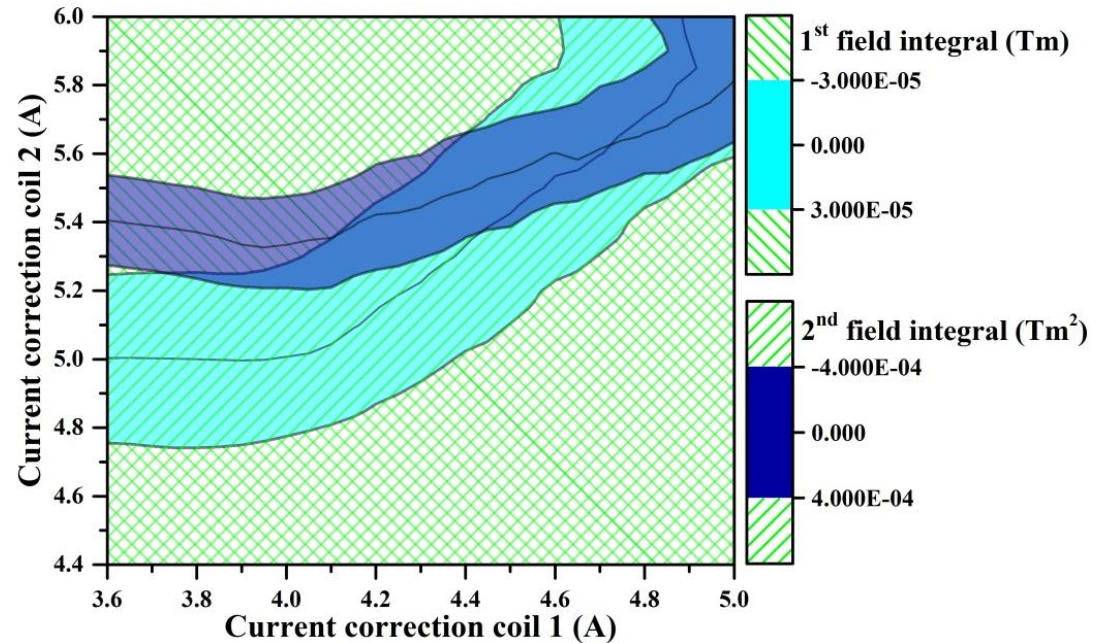

**Striped area:**

At least one integral out of specification

**Overlap region:**

1<sup>st</sup> and 2<sup>nd</sup> integral in specification.

**Helmholtz coil (HH DS) is used to correct  $I_{1v}$**   
**AUX 1 is used to correct for  $I_{2v}$**

S. Gerstl et al., IPAC 2015

A. Grau et al., IEEE Trans. on Appl. Supercond., Vol. 26-4, June 2016

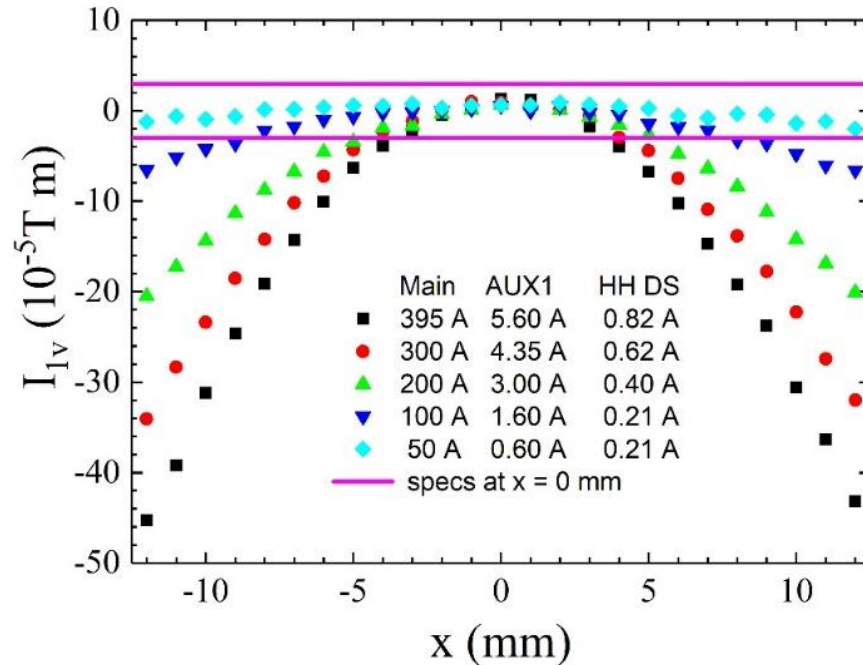

## Determination of integrated multipole components

- Set currents for main coils and correction coils (5 current steps, 0 A - 395 A)
- Perform integral measurements at different x-positions (stretched wire shifted in the middle plane of the magnetic gap)

- First & second vertical field integrals minimized below  $|I_{1v}| < 3 \times 10^{-5} \text{ Tm}$ , and  $|I_{2v}| < 4 \times 10^{-4} \text{ Tm}^2$ .
- To reach  $|I_{1h}| < 3 \times 10^{-6} \text{ Tm}$ , and  $|I_{2h}| < 10^{-5} \text{ Tm}^2$ . Correctors will be added outside the cryostat.
- For all currents the values of the integrated multipoles are small enough not to change the dynamic aperture of the beam for the 2.5 GeV operation of the KIT storage ring.

S. Casalbuoni et al, IEEE Trans. on Appl. Supercond. 4100704 Vol. 28-3 (2018)

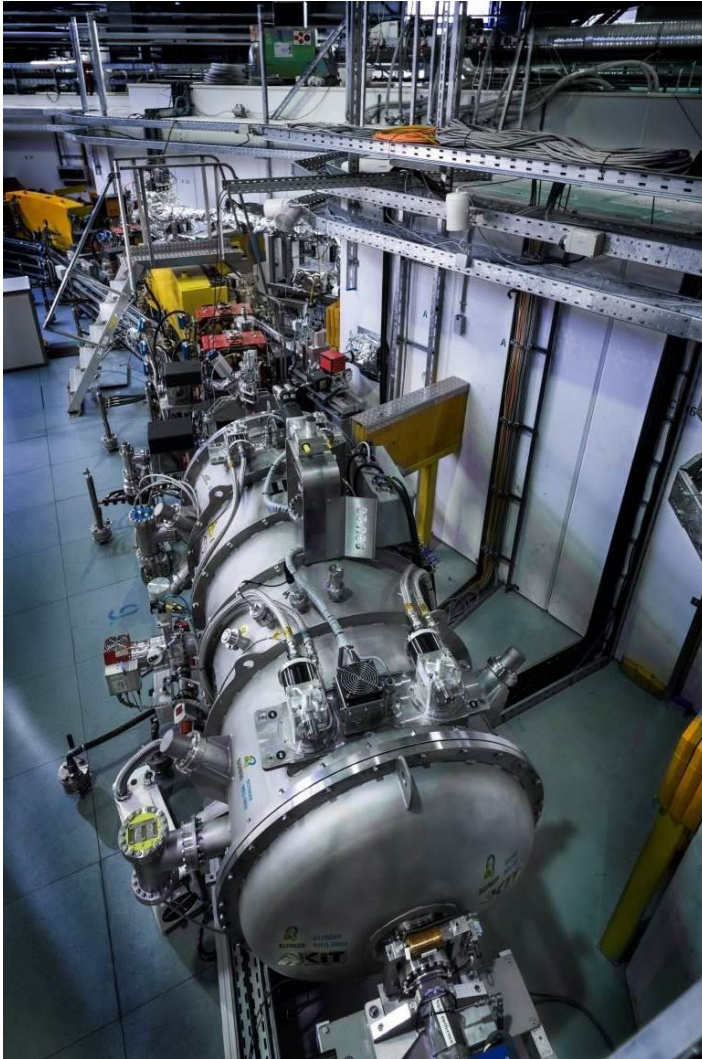

- After installation and testing the SCU20 coils in the final cryostat, the undulator was installed in December 2017.
- Successfully operating in the KIT synchrotron since January 2018 without quenches
- First X-rays 10.01.2018

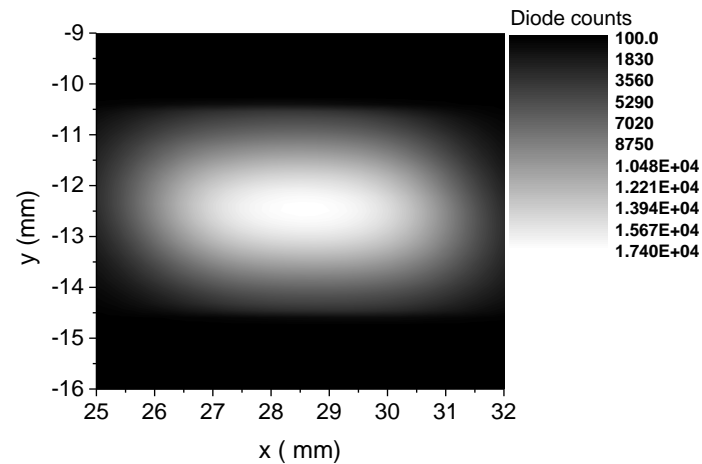

Image of white beam scanning diode after  $15\mu\text{m}$  pinhole @ 17.1m from the source and CVD diamond window  $3\text{mm} \times 2\text{mm}$  @ 8.3m

S. Casalbuoni et al, AIP Conference Proceedings 205 030025 (2019)

From prototype to product:

Design and manufacturing have been optimized to improve performance and reliability

SCU20 is the first commercially available superconducting undulator worldwide:

- a robust device.
- with reasonable delivery time (approx. 2 years).
- easy handling during installation and operation.
- Beam lifetime (23 h at 100 mA) recovered in about 3 weeks of beam operation of the storage ring at 2.5 GeV.



- Adjustment of the currents in the vertical and horizontal correctors (same as in CASPER II ) in a few hours.
- Tuning of SCU20 is compatible with the operation of all the beamlines of the KIT synchrotron while performing their most sensitive experiments.

## Magnetic field measurement setup for superconducting undulators in the final cryostat

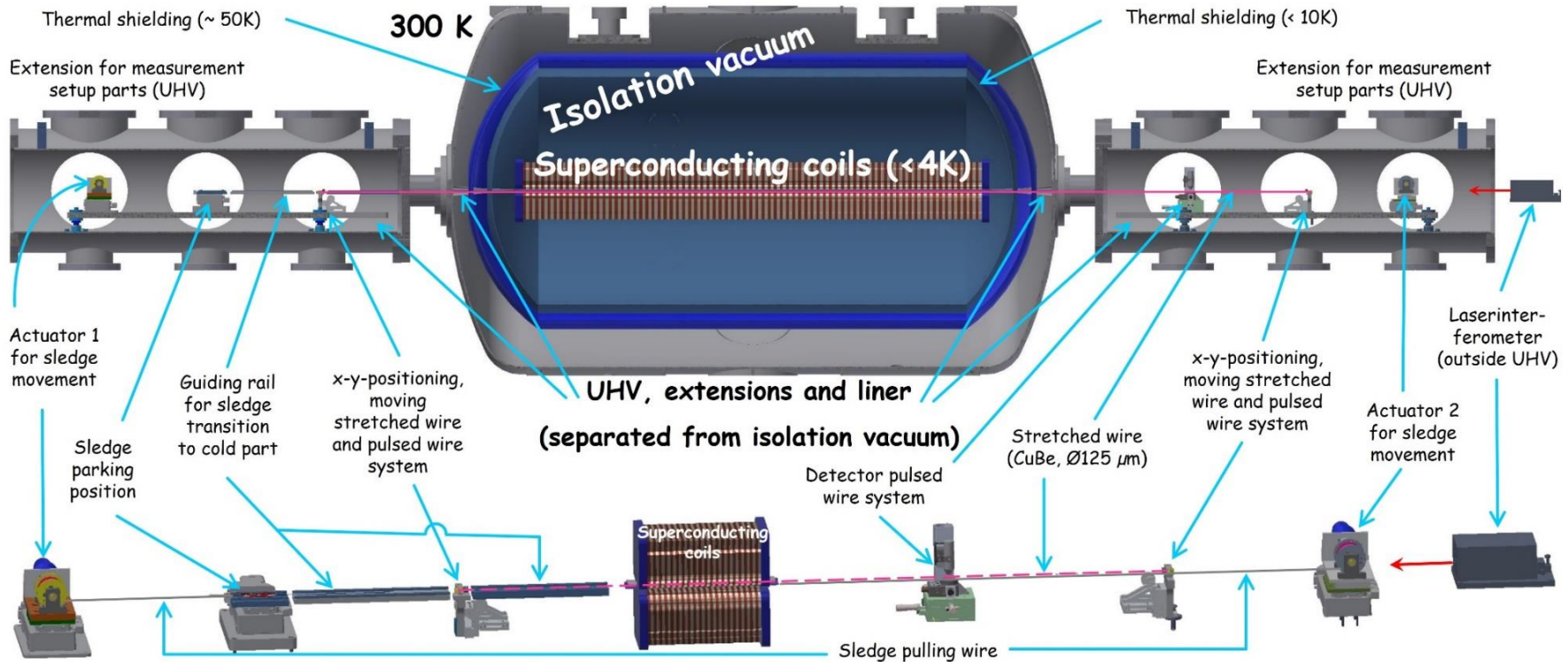

Measurement system capable to be adapted to various superconducting insertion device types (all equipment UHV compatible).

3 different measurement techniques can be applied within the same cooldown.

A. Grau et al., IPAC19

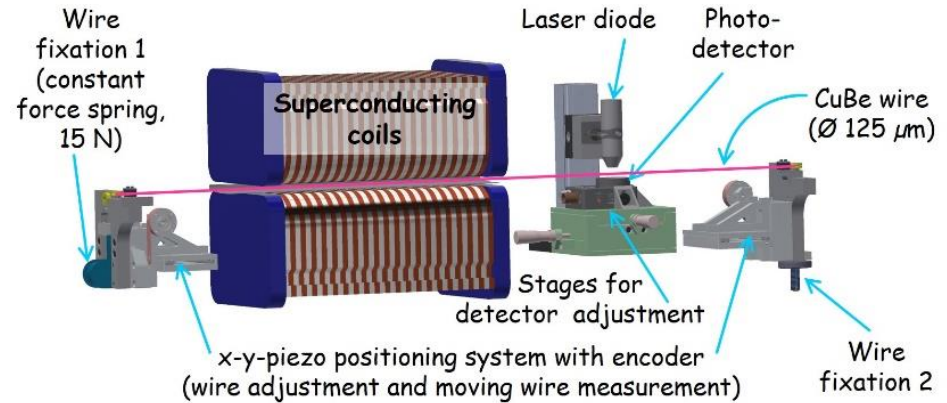
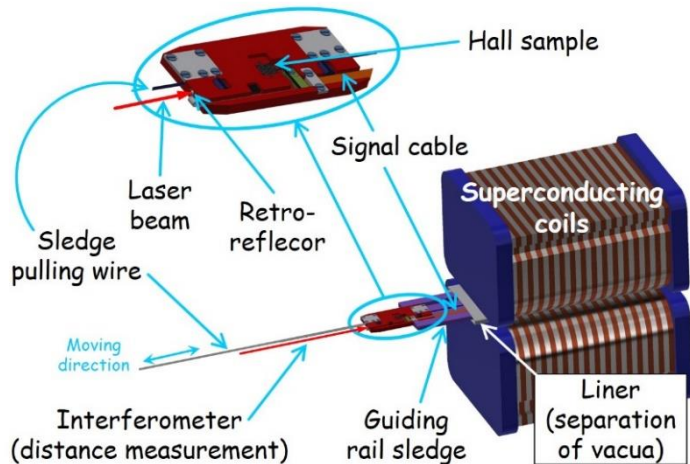

- Local field measurements by a calibrated Hall sample on a ceramic sledge guided by a ceramic guiding rail.

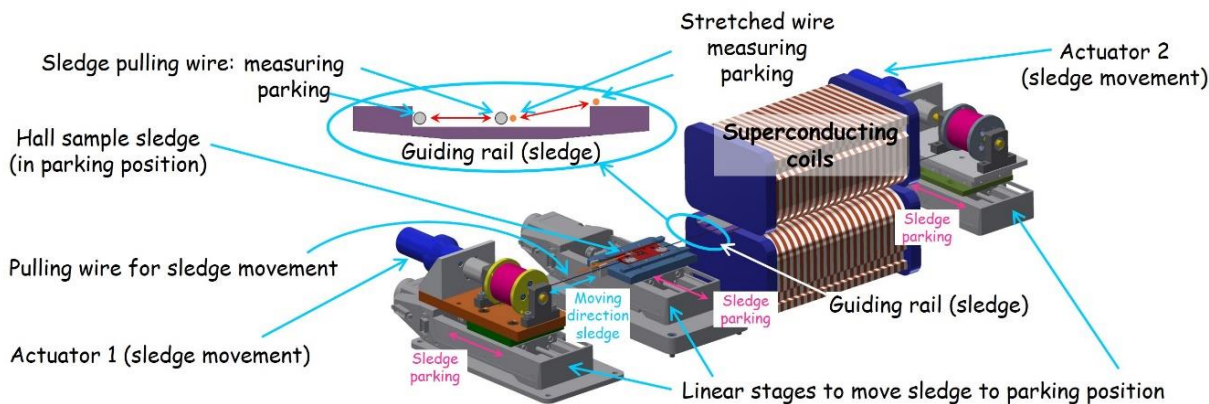

- Stretched wire system suitable to perform:

- a fast measurement of the longitudinal field integral profile by the pulsed wire technique.
- precise determination of the values for the 1<sup>st</sup> and 2<sup>nd</sup> field integrals and the optimization.

A. Grau et al., IPAC19



## Switchable period length SCU (period length doubling)

Motivation:

Reach full tunability with SCU17 and high brilliance in the soft X-ray regime with the 1st harmonic of SCU34 to measure some or all M-absorption edges of metals like V, Cr, Mn and Fe, going as low as few tens of eV in a low emittance light source with 3 GeV electron beam energy.

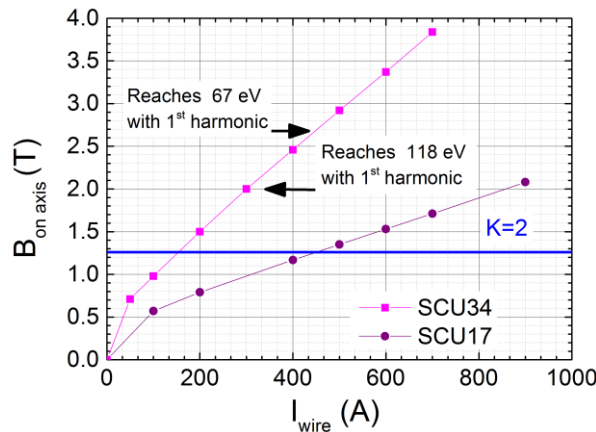
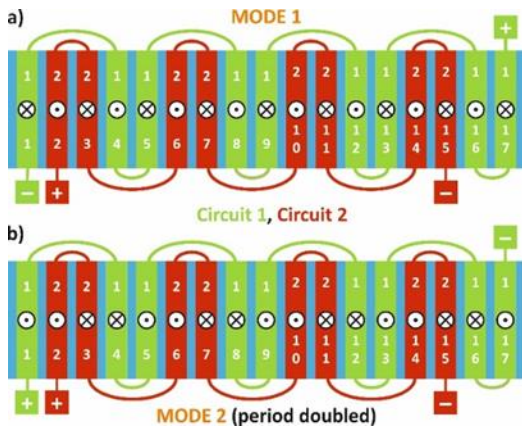

Simulations performed with FEMM\*, magnetic gap=6mm

450mm mock-up, test (CASPER I)

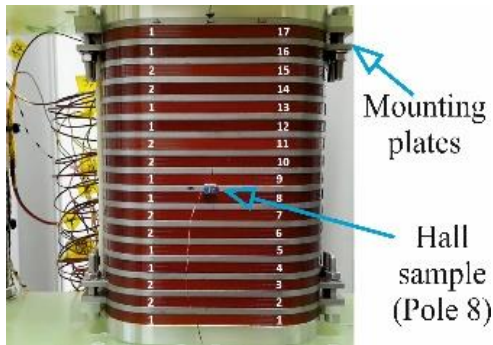

NbTi rectangular wire:  
1.08mmx0.58mm including insulation

T. Holubek et al., IPAC18  
S. Casalbuoni et al., IPAC19

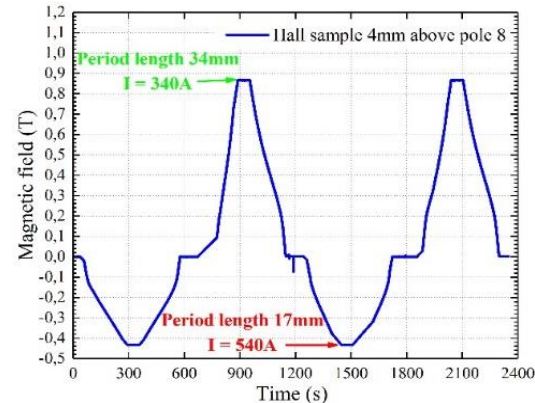

\* <http://www.femm.info>

- The CASPER II magnetic measurement setup works nicely and reliably.
  - Quench detection and analysis system is fully functional at high level.
  - Local field measurements executed over a length of 1800mm.
  - Field integral measurement setup and optimization procedure performs excellent.
- CASPER II capabilities confirmed by the precise magnetic characterization of the 1.5m long SCU20 coils.
  - Good agreement between magnetic field simulations with mechanical accuracies at room temperature and measured field profile at 4K.
  - SCU20 device is transparent to electron beam with values of correctors very close to the ones measured in CASPER II.
  - Tuning compatible with all beamlines at the KIT synchrotron.
- CASPER II measurement setup transfer to measurement system for superconducting undulators in the final cryostat.

Karlsruhe Institute of Technology

Companies

IBPT Technical staff

CryoVac

ITeP

SIOS

IBG

National Instruments



# Backup slides

Task within our R&D program :

Improvement of **magnetic field properties** and quality assessment.

Magnetic errors can cause:

Perturbation of the closed orbit and the dynamics of the electron beam

➔ **Field integral measurements are needed**

Reduction of the quality of the emitted radiation

➔ **Perform local field measurements to obtain phase error**

Field errors are mainly caused by:

- Mechanical deviations of the pole position e.g. the pole height
- Deviations in the period length
- Bending of the yoke
- The position of the superconducting wire bundles
- Pole and wire bundle size

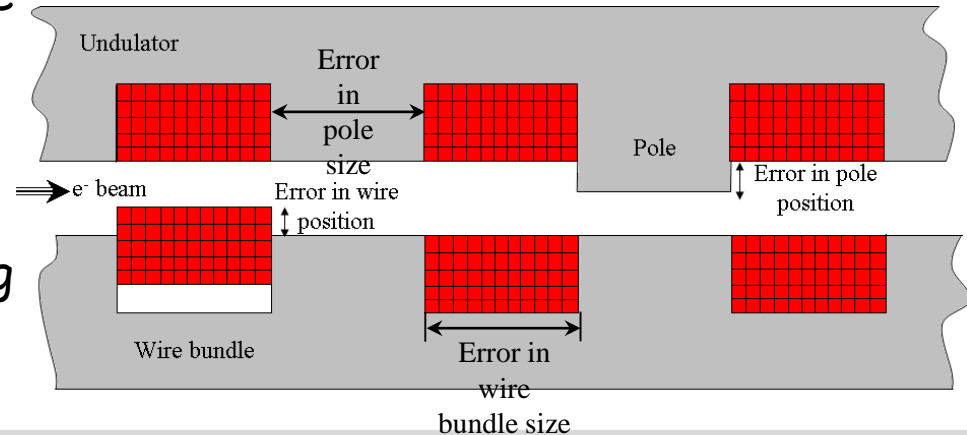

- Perform magnet training and quench tests
- test new winding schemes,
- new superconducting materials and wires,
- and new field correction techniques
- Operating vertical
- Test of mock-up coils in LHe
- Maximum dimensions 45 cm in length and 35 cm in diameter
- Magnetic field distribution measured with 3 calibrated Halls samples on a sledge moved by linear stage from outside.

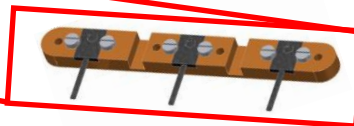
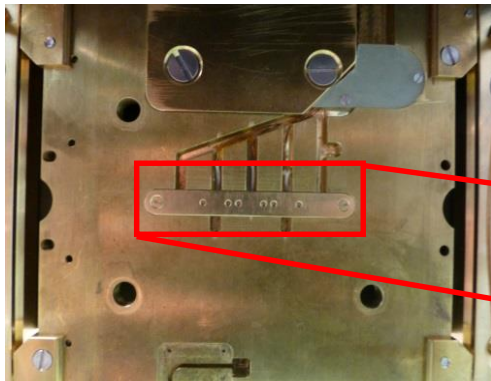
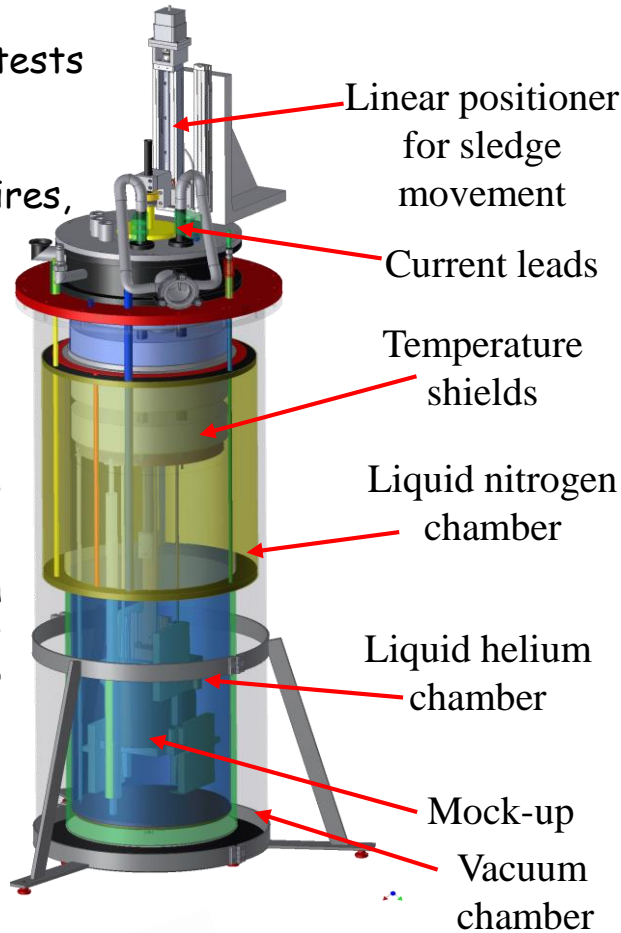

- $\pm 1500$  A/ $\pm 5$  V power supplies
- Quench detector for coil protection
- Data logging system for quench analysis

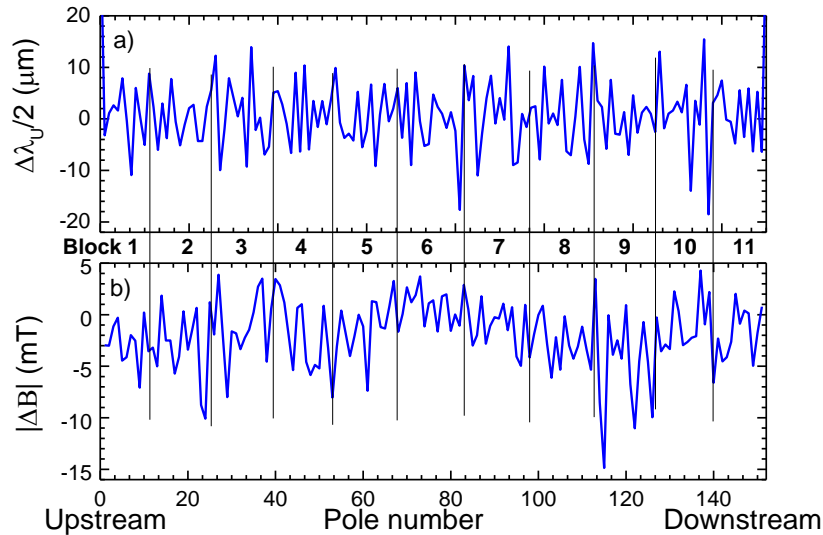

$\Delta\lambda_U/2$  = difference between  $\lambda_U/2$  calculated from the measured and simulated field profiles.

$|\Delta B|$  = difference between the absolute value of the peak magnetic field calculated from the measured and simulated field profiles.

- During winding, impregnation and/or cooldown some of the connections between the blocks get looser increasing  $\Delta\lambda_U/2$  up to about  $15 \mu\text{m}$ .

Current main coils (A)	$I_{1v}$ ( $10^{-5}Tm$ )	$I_{2v}$ ( $10^{-4}Tm^2$ )	Quad. (T)	Sext. (T/m)	Oct. (T/m <sup>2</sup> )	$I_{1h}$ ( $10^{-5} Tm$ )	$I_{2h}$ ( $10^{-4} Tm^2$ )
	< 3 >-3	< 4 >-4	< 0.005 >-0.005	< 0.1 >-0.1	< 100 >-100	< 0.3 >-0.3	< 0.1 >-0.1
50	0.6	-0.29	-0.0003	-0.2	-0.2	-3.6	-0.47
100	0.5	0.64	-0.0004	-0.5	0.8	-12	-1.7
200	0.6	0.09	0.0002	-1.4	11	-34	-4.7
300	0.9	0.28	-0.0006	-2.4	10	-53	-7.4
395	1.3	-0.8	-0.0008	-3.0	14	-71	-9.7



## Field integral optimization during ramping procedure (minimize influence on the e-beam)

- Specified field integral values have to met for all currents during a ramp.
- For different current ranges in the main coils, different ramping speeds are applied.
  - Ramping speed of corrections coils have to be adapted
- Tight mesh of correction current values is needed

Current main coils (A)	Ramp rate main (A/s)	Current AUX1 (A)	Ramp rate AUX1 (A/s)	Current HH DS (A)	Ramp rate HH DS (A/s)
0 – 5 5 – 20	0.0847 0.4233	0 – 0.05	0.0005	0 – 0.4	0.0042
20 – 25 25 – 50	0.4233 0.8467	0.05 – 0.6	0.0136	0.4 – 0.21	-0.0047
50 – 100	2.2833	0.6 – 1.6	0.0457	0.21	0
100 – 150	2.2833	1.6 – 2.3	0.0320	0.21 – 0.3	0.0041
150 – 200	2.2833	2.3 – 3	0.0320	0.3 – 0.4	0.0046
200 – 250	2.2833	3 – 3.65	0.0297	0.4 – 0.51	0.0050
250 – 300	2.2833	3.65 – 4.35	0.0320	0.51 – 0.62	0.0050
300 – 350	2.2833	4.35 – 5	0.0297	0.62 – 0.72	0.0046
350 – 395	2.2833	5 – 5.6	0.0304	0.72 – 0.82	0.0051
395 – 350	2.2833	5.6 – 5	-0.0304	0.82 – 0.72	-0.0051
350 – 300	2.2833	5 – 4.35	-0.0297	0.72 – 0.62	-0.0046
300 – 250	2.2833	4.35 – 3.65	-0.0320	0.62 – 0.51	-0.0050
250 – 200	2.2833	3.65 – 3	-0.0297	0.51 – 0.4	-0.0050
200 – 150	2.2833	3 – 2.3	-0.0320	0.4 – 0.3	-0.0046
150 – 100	2.2833	2.3 – 1.6	-0.0320	0.3 – 0.21	-0.0041
100 – 50	2.2833	1.6 – 0.6	-0.0457	0.21	0
50 – 25 25 – 20	0.8467 0.4233	0.6 – 0.05	-0.0136	0.21 – 0.4	0.0047
20 – 5 5 – 0	0.4233 0.0847	0.05 – 0	-0.0005	0.4 – 0	-0.0042

- Seventh harmonic of SCU20 measured at the NANO beamline through  $70 \mu\text{m} \times 30 \mu\text{m}$  at 17 m from the source with an ionization chamber at 2.5 GeV electron beam energy.

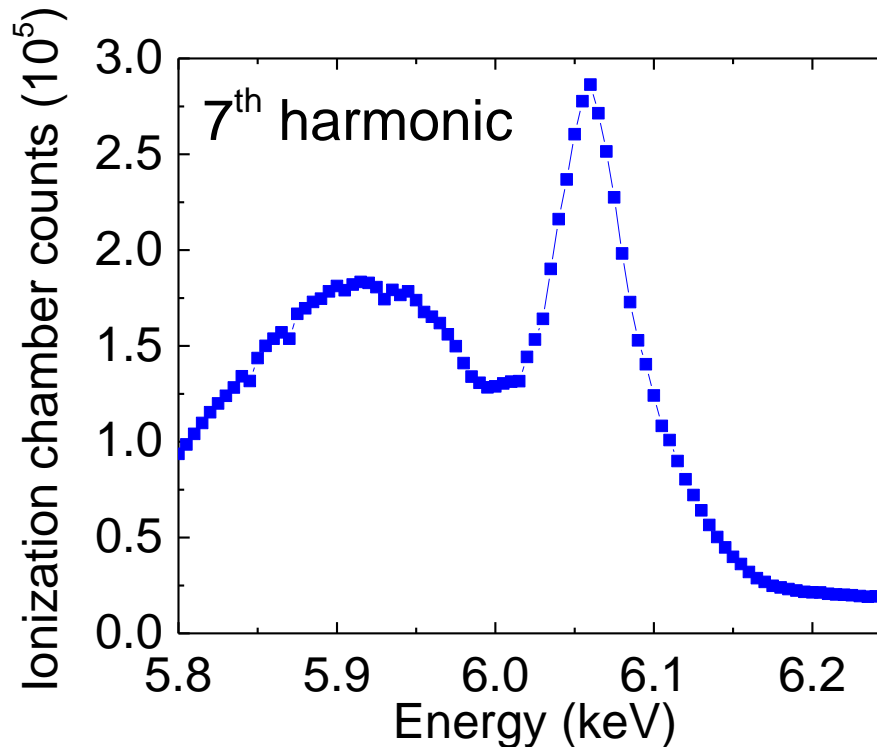

- Characterization with beam ongoing

S. Casalbuoni et al., SRI2018

## Jointless HTS tape stacked undulator for table top FELs

First magnetic field measurements  
on 30 stacked HTS laser structured tapes

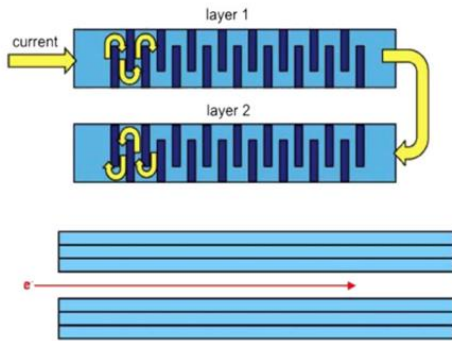

S. Prestemon et al., IEEE Trans. on Appl. Supercond. 1880-1883 Vol. 21-3 (2011)

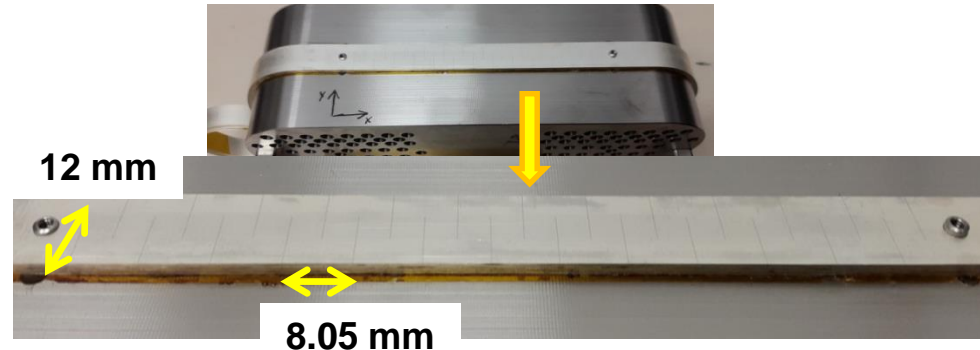

$I = 1000$  A, 2 mm above the HTS tape stack,  
maxima and minima variation within 16 mT

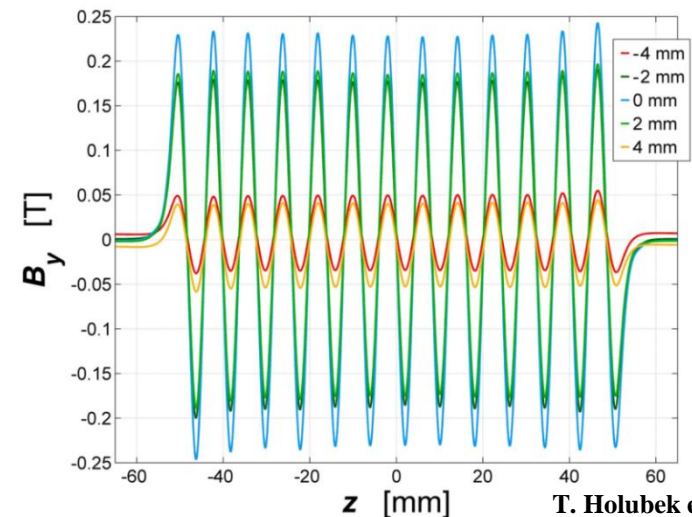

T. Holubek et al., ASC16

## Novel winding scheme without joints

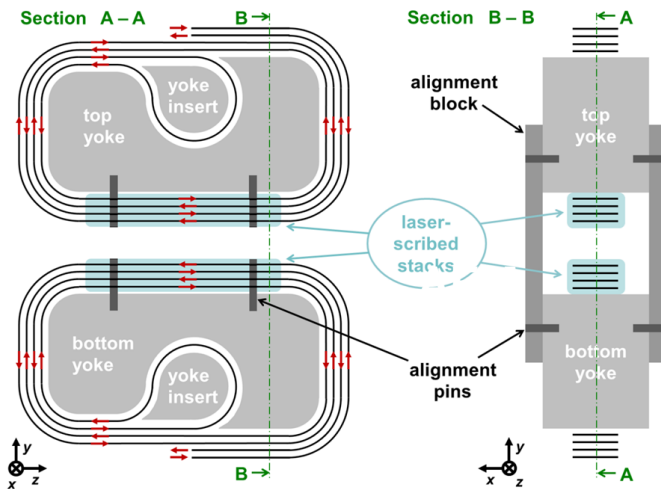

T. Holubek et al., Supercond. Sci. Technol. 30 115002 (2017)